



## MeshGuard LEL



# Contents

1	Standard Kit .....	6
2	General Information.....	6
3	Physical Description .....	8
3.1	LCD Display .....	9
3.2	Specifications.....	10
4	Operating The MeshGuard LEL .....	11
4.1	Turning The MeshGuard LEL On .....	11
4.2	Turning The MeshGuard LEL Off.....	12
4.3	Low Battery Indicator & Action .....	13
4.4	Resetting After An Alarm.....	13
4.5	Wireless Communication Indicator .....	14
4.6	Operation Modes.....	15
4.7	Detection Mode.....	17
4.8	Manually Sending Data.....	18
4.9	Programming Mode .....	19
4.9.1	Entering Programming Mode .....	20
4.9.2	Exiting Programming Mode .....	21
4.9.3	Zero Calibration .....	22
4.9.4	Span Calibration.....	23
4.9.5	Change High Alarm .....	25
4.9.6	Change Low Alarm.....	26
4.9.7	Change SPAN value .....	27
4.9.8	Change Pan ID .....	27
4.9.9	Join Mesh Network .....	28
4.9.10	Change Communication Interval .....	28
5	Diagnostic Mode.....	29
5.1	Entering Diagnostic Mode .....	29
5.2	Exiting Diagnostic Mode .....	30
5.3	Diagnostic Mode Readings .....	30
5.3.1	Sensor Raw Count.....	30
5.3.2	Battery Raw Count.....	30
5.3.3	Temperature Raw Count .....	30
5.3.4	Zero Raw Count .....	31
5.3.5	Calibration Delta Counts.....	31
5.4	Diagnostic Mode Programming.....	31

5.4.1 Radio Enable/Disable..... 33  
5.4.2 Enable STD or RTR..... 33  
5.4.3 Factory Setting ..... 33  
5.4.4 Audible & Visible Alarm Enable/Disable ..... 33  
6 Sensor And Battery Replacement ..... 34  
6.1 External Battery Usage ..... 35  
6.2 Sensor Filter Replacement ..... 38  
6.3 Sensor Replacement..... 39  
7 Troubleshooting ..... 40  
8 Alarm Signal Summary..... 42  
9 Appendix A..... 43  
10 Appendix B: Controlled Part Of Manual ..... 44

# WARNINGS

## Read Before Operating

This manual must be carefully read by all individuals who have or will have the responsibility of using, maintaining, or servicing this product. The product will perform as designed only if it is used, maintained, and serviced in accordance with the manufacturer's instructions.

### Warning:

Use only the Lithium battery or external rechargeable battery provided by Honeywell Analytics. This instrument has not been tested in an explosive gas/air atmosphere having an oxygen concentration greater than 21%. Substitution of components may impair suitability for intrinsic safety. Replace batteries only in non-hazardous locations.

**STATIC HAZARD:** Clean only with a damp cloth.

For safety reasons this equipment must be operated and serviced by qualified personnel only. Read and understand instruction manual completely before operating or servicing. Any rapid up-scale reading followed by a declining or erratic reading may indicate a gas concentration beyond upper scale limit, which may be hazardous.

Intrinsically safe marking:

IECEX TSA 09.0001X Ex ia I/II T4

CE 0575  IM1/II 1G Ex ia I/II C T4

DNV 09 ATEX 55990 X

cCSAus Class I, Division 1, Groups A,B,C, D T4

$-40^{\circ}\text{C} \leq T_{\text{amb}} \leq 50^{\circ}\text{C}$

Entity Parameters:  $U_i = 3.6\text{V}$ ,  $C_i = 67\mu\text{F}$ ,  $L_i/R_i = 3.5\mu\text{H}/\text{ohm}$

### Warning:

cCSAus certification only applies for fixed installations.

# 1 Standard Kit

- Monitor with antenna
- User's Guide
- CD with resources
- Maintenance tool
- Calibration certificate
- Calibration adapter

# 2 General Information

MeshGuard LEL (FTD-3000) is a single combustible-gas LEL (Lower Explosive Limit) detector integrated with a wireless mesh network-enabled transmission radio module. The detector has the option of relaying the wireless signal to other MeshGuard LELs as needed, to bypass obstacles. The MeshGuard LEL's built-in radio board operates on a frequency of 2.4GHz and complies with IEEE 802.15.4 standard. The MeshGuard LEL works with the FMC-2000 wireless controller on a flexible, robust wireless network to provide reliable, low-cost operation. It also works in a ProRAE.net network with a PC, and it supports point-to-point and point-to-multi-point networks.

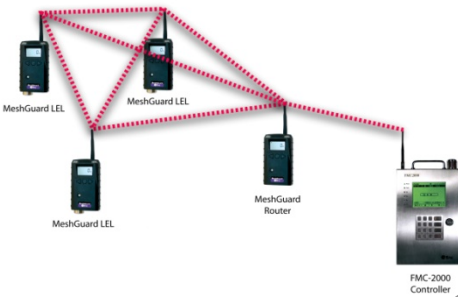

**MeshGuard LEL network with FMC-2000 controller**

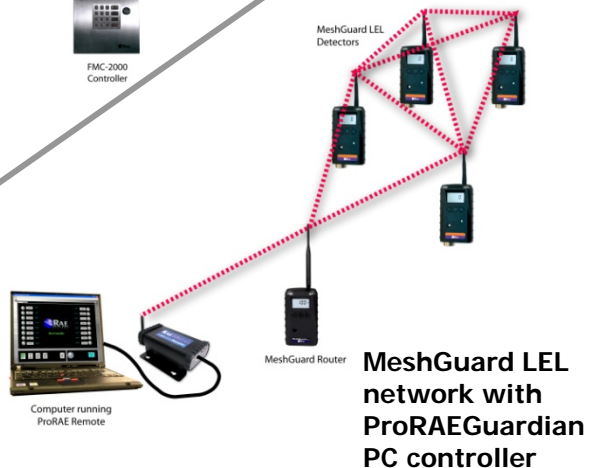

**MeshGuard LEL network with ProRAEGuardian PC controller**

## **Key Features**

- Up to 20 days continuous operation using external battery box
- IEEE 802.15.4 Mesh network functionality with 64-bit encryption
- Mesh network with auto network forming and configuration
- Operating distance: up to 300 m, line of sight
- Very low-cost installation – no hardwiring involved
- Large area coverage with multi-hop mesh network
- Field-replaceable battery and sensor
- Loud audio alarm, 90dB @ 30cm (12")
- Large, easy-to-read continuous display of LEL in %
- User-adjustable high and low alarms
- Bright red flashing alarm
- Simple calibration
- Highly resistant to RFI interference
- IP-65 rated for outdoor use in harsh environments

### 3 Physical Description



1	LED alarm
2	LCD
3	Buzzer alarm
4	Sensor gas inlet
5	Battery cover (on bottom)
6	Y/+, MODE, and N/- keys
7	Antenna

### 3.1 LCD Display

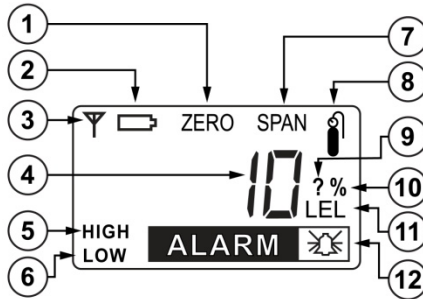

1	Zero Calibration
2	Battery Indicator
3	Wireless Communication (if on, the monitor is in STD; if blinking, the monitor is in RTR)
4	Reading Value
5, 12	High Alarm
6, 12	Low Alarm
7, 8	Span Calibration
9	Save Setting?
10	LEL Unit
11	LEL Percentage (%)
12	Alarm Indicator
Remark:	Concentration unit is shown as percentage of LEL.

## 3.2 Specifications

<b>RF Certifications</b>	FCC Part15 CE EN 300328 SRRC(Pending)
<b>Display</b>	Customized LCD (1 x 1.5") with backlight
<b>Audible alarm</b>	90dB @ 30cm
<b>Visual alarm</b>	2 super-bright red LEDs
<b>Calibration</b>	Two-point field calibration
<b>RF</b>	IEEE 802.15.4/Zigbee with mesh stack
<b>Operating Range</b>	Up to 300 meters, line of sight
<b>Transmission Power</b>	Up to 18dBm (63mw EIRP)
<b>Receiver Sensitivity</b>	Minimum -95dBm at 2.4GHz
<b>User Interface</b>	Three keys (Y/+, MODE, N/-)
<b>Power Supply</b>	Disposable lithium battery, +3.6V (optional rechargeable external battery for extended run time)
<b>Max Current Consumption</b>	300mA@3.6V during transmission 100mA@3.6V during standby
<b>Operation Time</b>	Internal Battery: STD* Mode: up to 5 days RTR** Mode: up to 4 days  External Battery: STD Mode: up to 20 days RTR Mode: up to 15 days  *STD is standard-function device **RTR is router-function device
<b>Operating Temperature</b>	-40° to +50° C (-40° to 122° F)
<b>Humidity</b>	10% to 90% relative humidity, non-condensing
<b>Dimensions</b>	26.5cm x 9.5cm x 5.5cm (10.5" L x 3.7" W x 2.1" H)
<b>Weight</b>	0.6 kg (1.3 lbs)
<b>Package</b>	IP-65
<b>Mounting</b>	Optional stainless-steel bracket mount or magnetic mount; wall mount for external battery

## 4 Operating The MeshGuard LEL

Make sure the battery is installed before operating the MeshGuard LEL. Refer to page 34 for information on battery installation and replacement.

### 4.1 Turning The MeshGuard LEL On

Hold down the [MODE] key and release it when the MeshGuard LEL beeps. The monitor is now on, as indicated by the display:



The MeshGuard LEL briefly shows the firmware version (for example, “F1.0” means firmware version 1.0, “F2.0” means firmware version 2.0, etc.):



Then the MeshGuard LEL displays “SON” as the sensor comes on.



It begins a sensor warm-up and counts down by seconds from 15 to 1.

The MeshGuard LEL initiates network communication and shows these displays in alternation:

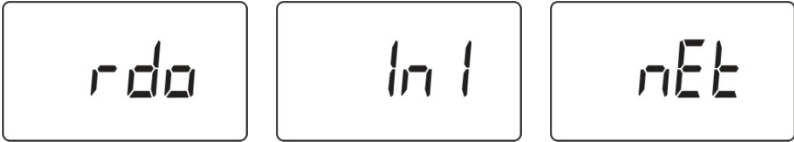

Note: If MeshGuard LEL is unable to find a radio network to connect with, it searches, and the display alternates between “rdo” and “Srh” (for “radio search”).



Next, if a network is located, an antenna icon appears (if no network is found, then the icon is not shown; press [Y/+] to search for a network).

The current gas concentration reading is also displayed:



The MeshGuard LEL is now operational.

## 4.2 Turning The MeshGuard LEL Off

Hold down the [MODE] key through the “5...4...3... 2... 1... oFF” sequence. The monitor is off when the display is blank. Release the [MODE] key.



The MeshGuard LEL is now off.

### 4.3 Low Battery Indicator & Action

The MeshGuard LEL's internal battery is designed for up to 5 days' continuous operation in STD mode, and the external battery for up to 3 weeks. When the battery gets low, the MeshGuard LEL beeps once per minute. It is recommended that the battery be changed immediately, to minimize disruption.



When the battery is completely depleted, the LCD displays “OFF,” and the LED, buzzer and vibration alarm activate once per second. The battery icon also blinks on and off. The MeshGuard LEL shuts down after you press any key, or shuts down automatically if you do not press a key for 60 seconds.

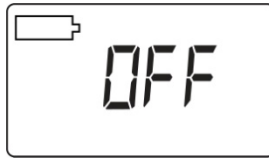

### 4.4 Resetting After An Alarm

When a gas concentration exceeds 100% of LEL, the MeshGuard LEL displays “OVR” and its buzzer and LED are activated. In order to reset the MeshGuard LEL and turn off the alarms from that event, press the [Y/+] key. This clears the alarm.

**Note:** Clearing the alarm does not shut off the sensor. Therefore, the next time the gas concentration exceeds 100% of LEL, the MeshGuard LEL will again alert you.

## 4.5 Wireless Communication Indicator

When wireless communication is turned on, the LCD displays the wireless link status in the upper left corner:



If the MeshGuard LEL finds and joins a wireless network, an antenna icon is shown in the display. If no link or a weak link is established, no antenna icon is shown. Press [Y/+] to manually search for a network.

In RTR mode, the antenna icon flashes on and off, indicating that the modem is always active and transmitting. With an external BatteryPak provided by Honeywell Analytics, it can run for up to 14 days.

In STD mode, the antenna icon is shown continuously (solid), indicating that the modem is active whenever alarm data is transmitted. This conserves battery power. With an external BatteryPak provided by Honeywell Analytics, it can run for up to 20 days.

## 4.6 Operation Modes

The MeshGuard LEL can operate in Standard (STD) or Router (RTR) mode. In STD mode, the MeshGuard LEL transmits data to the host at a set interval (the default is 30 seconds) or anytime an alarm occurs. In RTR mode, the MeshGuard LEL transmits data in real time, and it can also work as a router as needed to relay data from STD devices back to the host.

**Note:** Operating the MeshGuard LEL in RTR mode reduces battery life. The transmission interval can be changed in Programming Mode to extend battery life. See page 19 for details.

In addition, there is a Detection Mode for standard operation, Programming Mode for making changes to values (such as the High Alarm, etc.), Diagnostic Mode (for servicing and checking the sensor, etc.), and Diagnostic Programming Mode, which is for selecting between Standard (STD) & Router (RTR) modes, etc.

The diagram on the next page shows how to enter and step through the menus in each mode.

Enter Detection Mode by turning the MeshGuard LEL on. Enter Programming Mode from Detection Mode by holding down [MODE] and [N/-] together. To enter Diagnostic Mode, start with the MeshGuard LEL turned off and hold both [Y/+ ] and [MODE] to start it. Once Diagnostic Mode is on, enter Diagnostic Programming Mode by holding [N/-] and [MODE] together.

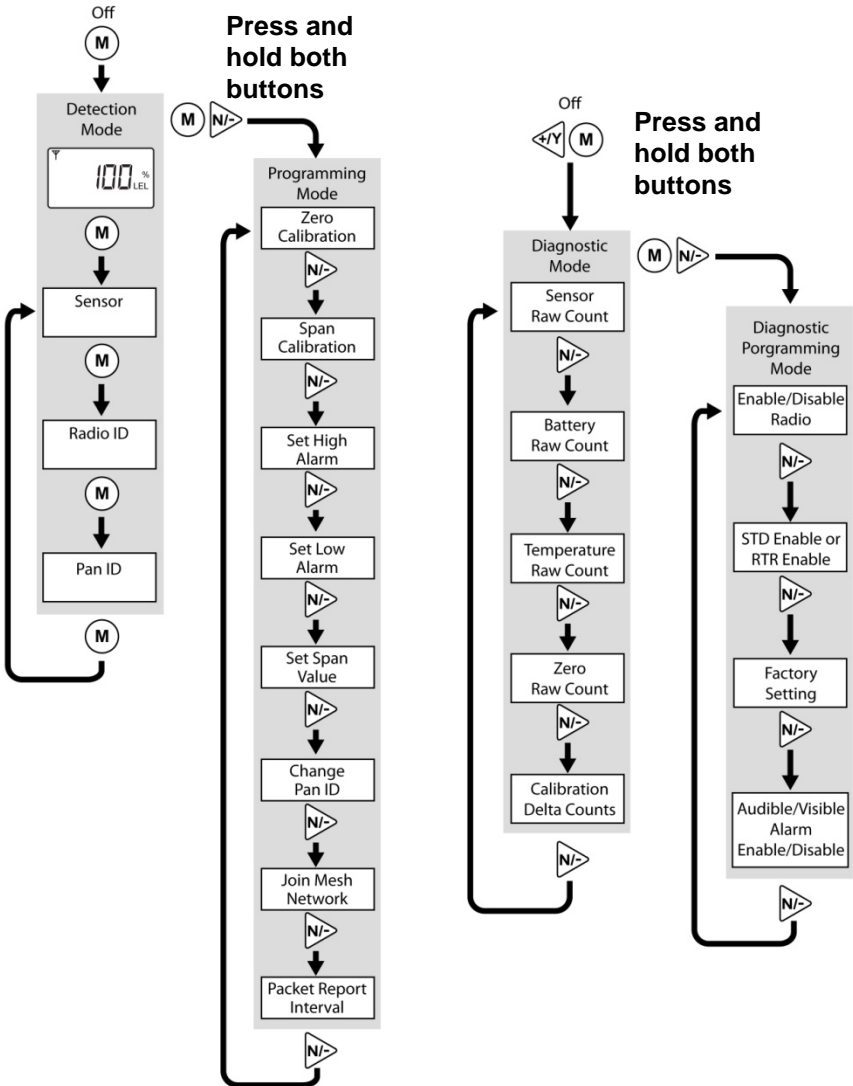

## 4.7 Detection Mode

Whenever you start MeshGuard LEL by pressing and holding [MODE], it is automatically in Detection Mode.

The MeshGuard LEL displays the current reading:



Pressing [MODE] steps through the Detection Mode screens:

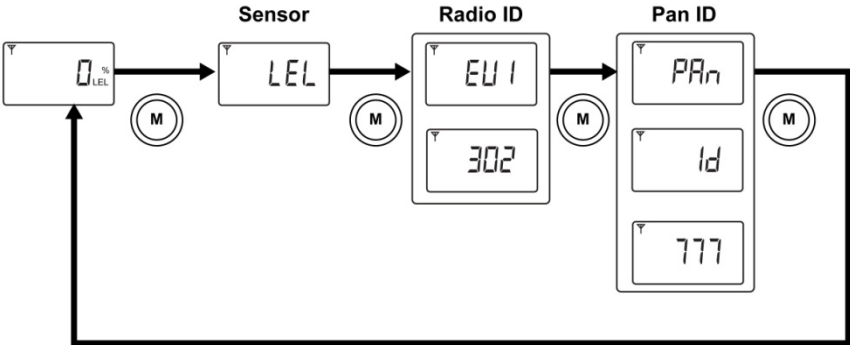

Press [MODE], and it displays the sensor type:



Press [MODE], and it alternates between EUI (Extended Unique Identifier) and its value; the EUI is a unique unit ID for each detector in a network:

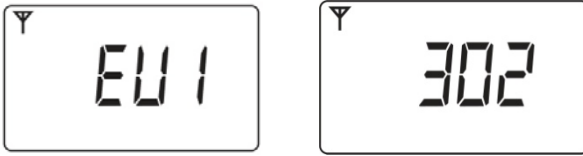

Press [MODE], and it alternates between Pan and ID (Personal Area Network Identifier) and its value (all units in a network must have the same Pan ID):



Press [MODE] to return to the detector reading:



**Note:** If you do not press a button for 60 seconds, or if an alarm condition occurs, the MeshGuard LEL automatically returns to the main reading screen.

## 4.8 Manually Sending Data

While the MeshGuard LEL typically sends reading data to the network on a fixed interval, you can send the data anytime.

Press the [Y/+] key. The screen alternates between “InI” and “nEt” one time, sends the current sensor data, and returns to the detector reading.

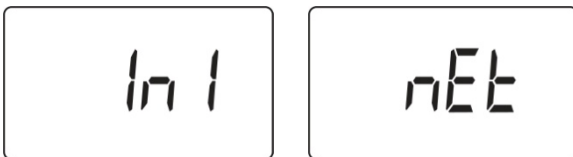

## **4.9 Programming Mode**

Programming Mode allows you to perform any of the following actions (listed in order of appearance):

- Zero Calibration
- Span Calibration
- High Alarm
- Low Alarm
- Change Span Value
- Change Pan ID
- Join Mesh Network
- Communication interval

### 4.9.1 Entering Programming Mode

To enter the Programming Mode, press [MODE] and [N/-] for 3 seconds while the MeshGuard LEL is on. “Pro” appears in the display:



Pressing [N/-] steps you through all the screens and then returns to the first programming display:

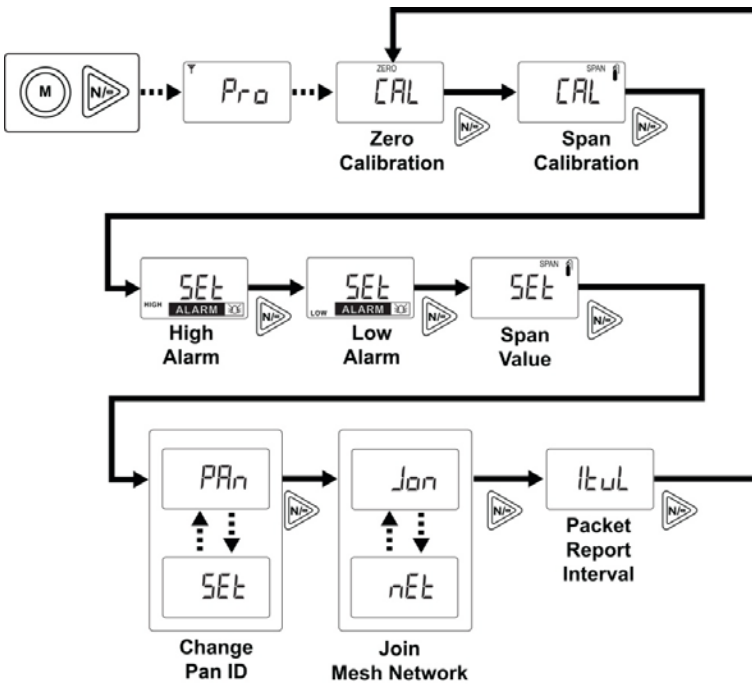

Each display alternates between its name and a status message or value.

**Note:** You can exit Programming Mode at any time by pressing [MODE]. Also, if you do not make a change within one minute, the MeshGuard LEL exits Programming Mode and returns to Detection Mode.

Settings can be changed as follows:

1. When a menu is selected, it flashes between two screens. For example:



2. Press [MODE] to exit Program Mode and return to Detection Mode, or press [N/-] to advance to the next menu.
3. Press [Y/+] to enter. The LCD displays “go.”

#### 4.9.2 Exiting Programming Mode

You may exit Programming Mode anytime and return to Detection Mode in either of these two ways:

1. Press [MODE]. MeshGuard LEL exits Program Mode and shows the current reading in Detection Mode.
2. Do not press any buttons for 1 minute. MeshGuard LEL automatically exits Programming Mode and returns to Detection Mode, showing the current reading.



### 4.9.3 Zero Calibration

When “CAL” and “go” are displayed in alternation, and “ZERO” is shown, the MeshGuard LEL is ready to perform a zero calibration.

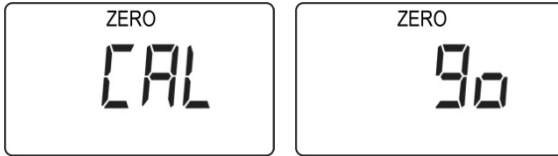

Press [Y/+]. The LCD displays “go.”

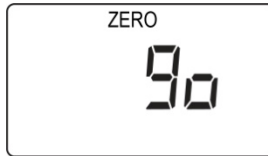

The display counts down from 30 to 0.



After the countdown reaches 0, the LCD displays “dn,” for “done.” The reading should show 0 (zero). Otherwise, repeat the zero calibration.



**Note:** When performing Zero Calibration, always make sure you do so in an environment with clean air.

**Note:** To stop zero calibration before the countdown reaches 0, press any key. The LCD displays “no” and advances to the next programming menu, Span calibration.

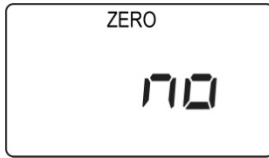

### 4.9.4 Span Calibration

“CAL” and “go” flash in alternation, and “SPAN” is shown. The MeshGuard LEL is now ready to perform a span calibration.

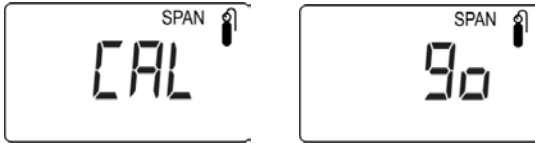

To start calibration, press [Y/+]. The LCD displays “go.”



The MeshGuard LEL waits for 10 seconds so that you have time to connect the span gas. Connect the calibration gas adapter to the MeshGuard LEL, and connect the gas cylinder to the adapter. Start the flow of gas.

When the gas flow starts, the LCD displays “gAS” and the span concentration value.

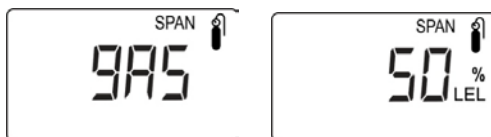

The MeshGuard LEL now counts down to 0.

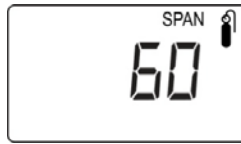

After counting down and reaching 0, the LCD displays “dn.” The reading should be the span concentration value. Otherwise, the span calibration should be repeated.

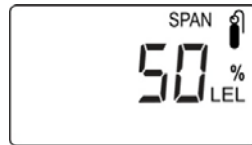

If the MeshGuard LEL does not detect gas after counting down to 0, the LCD displays “Err” (for “error”). The LED glows red and the buzzer sounds to provide extra warning. The MeshGuard LEL automatically returns to the span calibration display.

**Note:** This could mean the sensor is contaminated or expired.

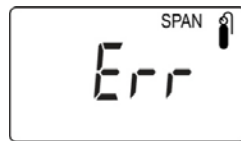

**Note:** To stop span calibration before the countdown reaches 0, press any key. The LCD displays “no” and advances to the next programming menu, Change High Alarm.



If the sensor fails, try to recalibrate it again. If calibration fails again, replace the sensor.

## 4.9.5 Change High Alarm

At the menu for changing the High Alarm setting, “Set” and “ go” flash in alternation, and both “HIGH” and “ALARM” are shown.

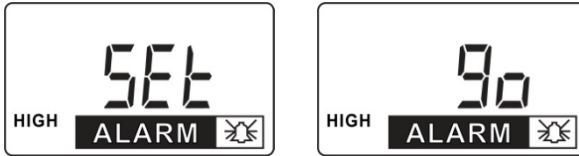

Press [Y/+] to enter and change the setting. Press [MODE] to go back to Detection Mode or [N] to advance to the next menu.

The LCD displays the current value. Change the value if necessary.



To change the value:

1. Press [Y/+] to increase the number and [N/-] to decrease it.
2. Press [MODE] to advance to the next digit.
3. After moving to the last digit and making changes, press [MODE]. A question mark (?) is shown in the display, asking if you want to save the change.
  - Press [Y/+] for yes. The message “dn” means the change is done.
  - Press [N/-] for no. A “no” message means that the change was abandoned.
  - Press [MODE] to return to the first digit.

## 4.9.6 Change Low Alarm

At the Change Low Alarm menu, “Set” and “go” flash in alternation, and “LOW” and “ALARM” are visible in the display.



Press [Y/+] to enter and change the setting. Press [MODE] to exit and return to Detection Mode or [N] to advance to the next menu.

The LCD displays current value. Change the value if necessary.



To change the value:

1. Press [Y/+] to increase the number and [N/-] to decrease it.
2. Press [MODE] to advance to the next digit.
3. After moving to the last digit and making changes, press [MODE]. A question mark (?) is shown in the display, asking if you want to save the change.
  - Press [Y/+] for yes. The message “dn” means the change is done.
  - Press [N/-] for no. A “no” message means that the change was abandoned.
  - Press [MODE] to return to the first digit.

## 4.9.7 Change SPAN value

“Set” and “go” flash in alternation, and “SPAN” and a gas cylinder icon are shown.

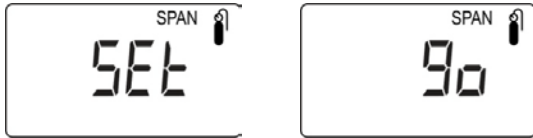

Press [Y/+] to enter and change the setting, [MODE] to exit and return to Detection Mode, or [N/-] to advance to the next menu.

The LCD displays the current value. Change the value if necessary.



To change the value:

1. Press [Y/+] to increase the number and [N/-] to decrease it.
2. Press [MODE] to advance to the next digit.
3. After moving to the last digit and making changes, press [MODE]. A question mark (?) is shown in the display, asking if you want to save the change.
  - Press [Y/+] for yes. The message “dn” means the change is done.
  - Press [N/-] for no. A “no” message means that the change was abandoned.
  - Press [MODE] to return to the first digit.

## 4.9.8 Change Pan ID

**Note:** All MeshGuards (including MeshGuard Routers) in a network must have the same Pan ID.

Press Y/+ to enter the menu to make changes to the value.

1. Press [Y/+] to increase the number and [N/-] to decrease it.
2. Press [MODE] to advance to the next digit.
3. After moving to the last digit and making changes, press [MODE]. A question mark (?) is shown in the display, asking if you want to save the change.
  - Press [Y/+] for yes. The message “dn” means the change is done.
  - Press [N/-] for no. A “no” message means that the change was abandoned.
  - Press [MODE] to return to the first digit.

### 4.9.9 Join Mesh Network

Press [Y/-] to initiate joining a network. Three bars flash in sequence while it searches. When it is done, it alarms once and displays “dn” for “done.”

### 4.9.10 Change Communication Interval

This menu allows you to change the interval between wireless transmissions. “SET” and “ItUL” flash, to indicate that you can change the interval. The interval can be set to 10, 30, 60, 300, or 600 seconds.

**Note:** The default interval is 30 seconds.



Press [Y/+] to enter and change the setting, [MODE] to exit and return to Detection Mode, or [N/-] to advance to the next MENU.

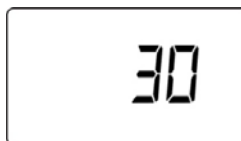

# 5 Diagnostic Mode

Diagnostic Mode provides raw data from sensors and about settings.

## 5.1 Entering Diagnostic Mode

**Note:** To enter Diagnostic Mode, you must begin with the MeshGuard LEL turned off.

Press and hold [Y/+] and [MODE] until the MeshGuard LEL starts.

The instrument goes through a brief startup, and then displays “dIA” to indicate it is in Diagnostic Mode. It then switches to showing raw data for the sensor (the display shows “rAU” followed by a number).

The following chart shows how to navigate Diagnostic Mode (pressing N/- repeatedly steps through the screens):

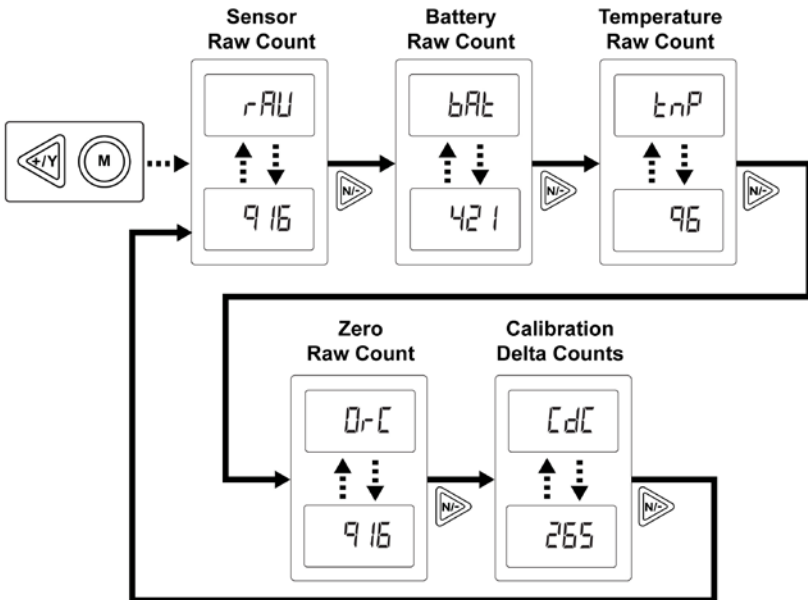

## 5.2 Exiting Diagnostic Mode

**Note:** You can exit Diagnostic Mode and enter Programming Mode and calibrate the MeshGuard LEL as usual by pressing both [MODE] and [N/-] for three seconds. When entering Programming Mode from Diagnostic Mode, additional menu options are available. Refer to the diagram on page 36 for more details.

**Note:** You can exit Diagnostic Mode and enter Detection Mode by pressing [MODE] and [Y/+] together for three seconds, or by turning it off and on again.

## 5.3 Diagnostic Mode Readings

In Diagnostic mode, you can step through readings by pressing [N/-].

### 5.3.1 Sensor Raw Count

Sensor Raw Count is indicated by “rAU” followed by a number.

- Press [N/-] to advance to the next reading.
- Press [MODE] and [Y/+] together for three seconds to exit Diagnostic Mode and enter Detection Mode.

### 5.3.2 Battery Raw Count

Battery Raw Count is indicated by “bAt” followed by a number.

- Press [N/-] to advance to the next reading.
- Press [MODE] and [Y/+] together for three seconds to exit Diagnostic Mode and enter Detection Mode.

### 5.3.3 Temperature Raw Count

Temperature Raw Count is indicated by “tNp” followed by a number.

- Press [N/-] to advance to the next reading.
- Press [MODE] and [Y/+] together for three seconds to exit Diagnostic Mode and enter Detection Mode.

### 5.3.4 Zero Raw Count

Zero Raw Count is indicated by “0rC” followed by a number.

- Press [N/-] to advance to the next reading.
- Press [MODE] and [Y/+] together for three seconds to exit Diagnostic Mode and enter Detection Mode.

### 5.3.5 Calibration Delta Counts

Calibration Delta CTS is indicated by “CdC” followed by a number.

- Press [N/-] to return to the first raw count.
- Press [MODE] and [Y/+] together for three seconds to exit Diagnostic Mode and enter Detection Mode.

## 5.4 Diagnostic Mode Programming

You can enter a special programming mode from Diagnostic Mode in order to perform advanced programming functions. These include:

- Enable/disable radio
- Enable STD or RTR
- Return the MeshGuard LEL to original factory settings
- Enable/disable audible and visible alarms

**Note:** When the MeshGuard LEL is in this programming mode, if you do not make a change or press a key for 60 seconds, it reverts to the standard Diagnostic Mode.

**Important!** After you make changes in Diagnostic Mode, it is recommended that you turn off the MeshGuard LEL and turn it on again before using it.

Enter this programming mode by first entering Diagnostic Mode. This requires starting the MeshGuard LEL while holding [Y/+] and [MODE]. When you see the Sensor Raw Count screen, hold [MODE] and N/- until you see “Pro” in the display, indicating that you are in Programming Mode.

Step through the menus by pressing [N/-]. Exit by pressing [MODE], and then shutting off the MeshGuard LEL and restarting it.

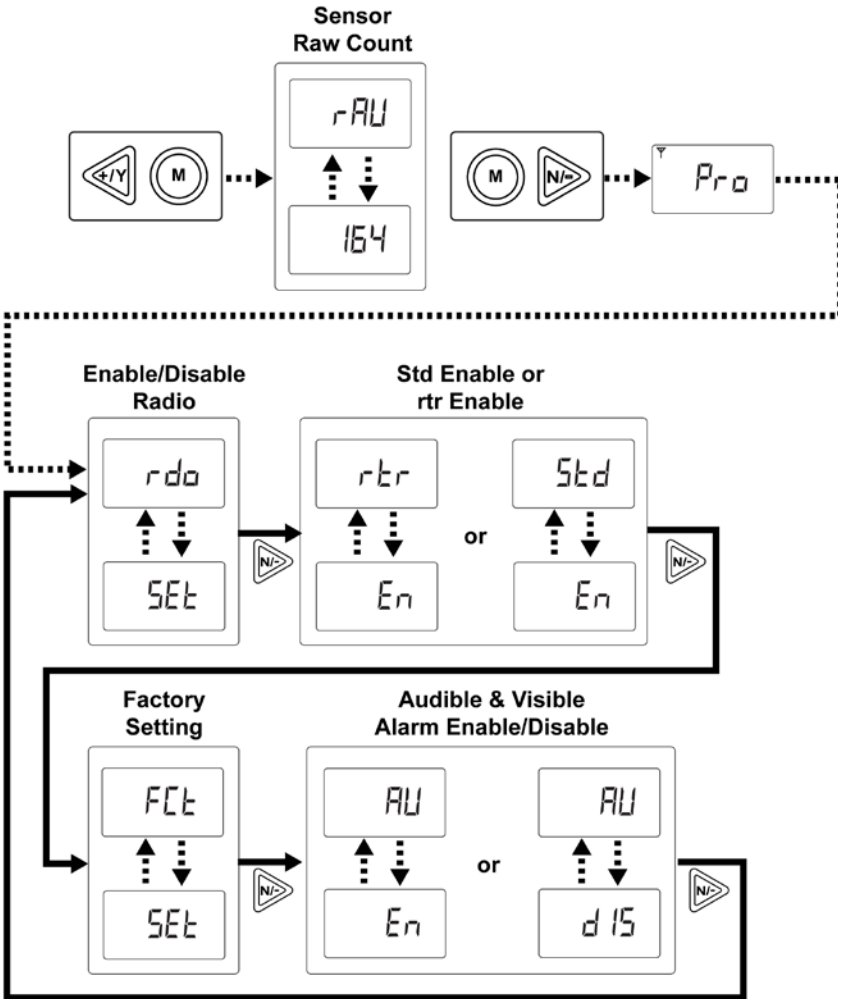

### 5.4.1 Radio Enable/Disable

The next menu is for turning the MeshGuard LEL’s radio on or off.

“SEt” and “rdo” flash in alternation, to indicate that the MeshGuard LEL radio can be turned on (enabled) or off (disabled). The default value is “on.”



Press [Y/+] to enter and change the setting, [MODE] to exit and return to Detection Mode, or [N/-] to go to the next menu.

The LCD displays the current value (enabled or disabled). Change the value if necessary.

**Note:** “dIS” means disabled (radio off) and “En” means on (radio on).

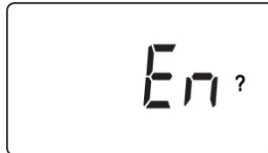

### 5.4.2 Enable STD or RTR

Press [Y/+] to toggle the setting from STD to RTR, and vice versa. For details on STD and RTR modes, see page 15.

### 5.4.3 Factory Setting

Press [Y/+] to return the MeshGuard LEL to its original factory settings.

### 5.4.4 Audible & Visible Alarm Enable/Disable

Press [Y/+] to toggle between the MeshGuard LEL’s audible and visible alarms turned on and off.

## 6 Sensor And Battery Replacement

**Note:** For clarity, MeshGuard LEL's enclosure is not shown.



Sensor compartment

Internal battery compartment

Sensor and battery removal tool

3-pin end



Hexagonal end  
(two pins on side not shown)

## 6.1 External Battery Usage

An external battery unit, Power Pack, provided by Honeywell Analytics, is used to power the MeshGuard LEL in situations where extended battery life is necessary. The connector from the external battery screws into the MeshGuard LEL's battery compartment. Bottom views of the MeshGuard LEL in its steel enclosure are shown in the procedure below.

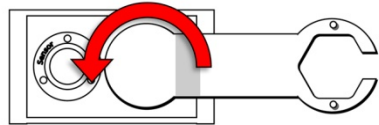
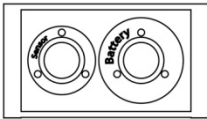

**1. Remove battery cover with the 3-pin end of the sensor and battery removal tool by turning counterclockwise.**

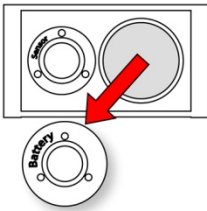

**2. Lift off the cover.**

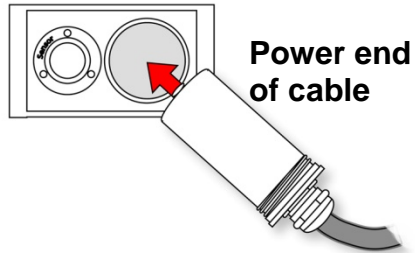

**3. Insert the power end of the cable connected to the Power Pack.**

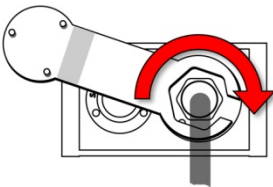

**4. Use the open hex end of the wrench, and with both pins mated with the two holes on the power end, tighten by turning clockwise until it is snug. Do not overtighten.**

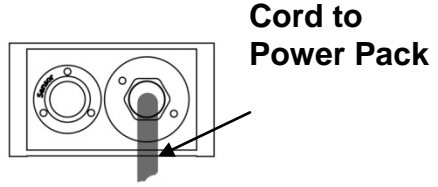

Consult the Honeywell Analytics Power Pack User's Guide for further connection and charging information.

The MeshGuard LEL is permanently mounted to a solid surface by first securing it in its steel enclosure (a screw through the back mates with the MeshGuard LEL) and then securing the enclosure to a solid surface such as a wall or the metal mounting plate.

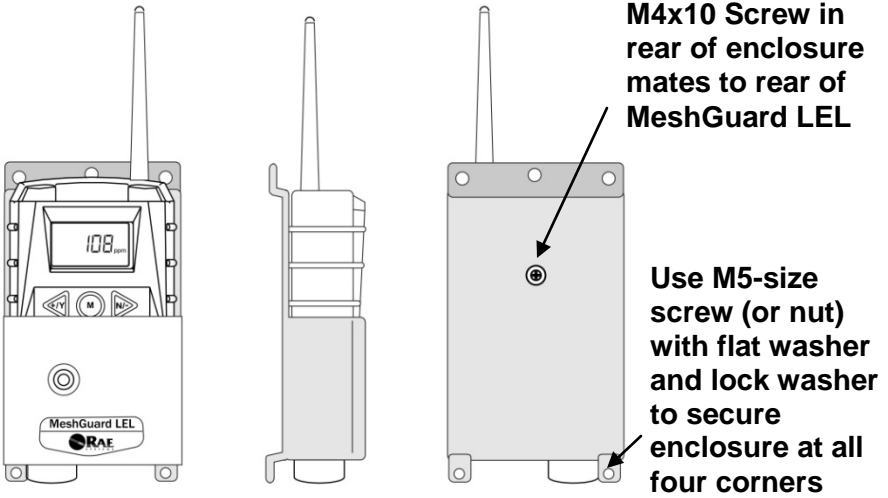

**Front, side, and rear views of the steel enclosure show how the MeshGuard LEL is secured for mounting.**

With the MeshGuard LEL securely in its housing, you can remove the cover over the battery compartment so that you can replace the internal battery in the MeshGuard LEL. Use the sensor and battery removal tool as shown.

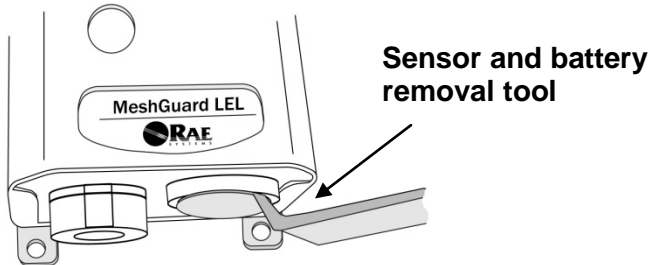

**WARNING:** Use only provided by Honeywell Analytics battery for the internal battery. If you need support with the p/n, please contact your Honeywell Analytics Representative. The internal battery must be replaced under a Hot Work Permit, where the atmosphere is determined to be non-hazardous while the battery is being replaced.

## 6.2 Sensor Filter Replacement

The filter should be replaced when it is visibly dirty. If readings fluctuate up even after a zero calibration, this may indicate a dirty filter.

1. Use the 3-pin end of the tool to unscrew and open the filter holder by turning it counterclockwise.

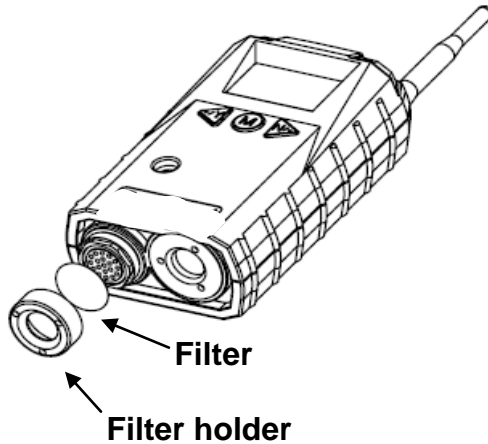

2. Remove and discard the filter.
3. Place a new filter inside the monitor.
4. Replace the filter holder by turning it clockwise with the 3-pin end of the tool.

## 6.3 Sensor Replacement

1. Use the 3-pin end of the sensor and battery tool to unscrew and open the filter holder at the bottom of the monitor.

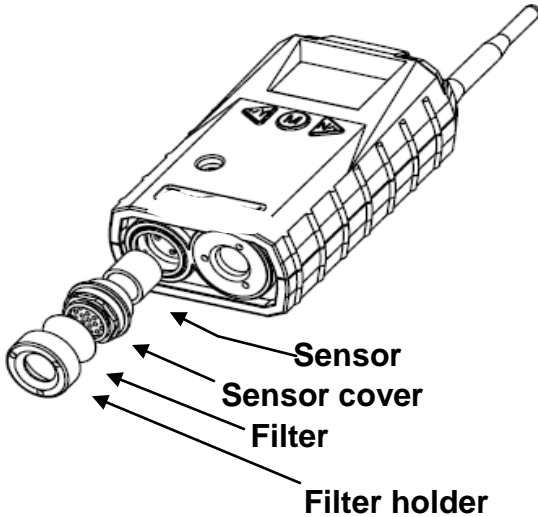

2. Use the hexagonal end of the tool to open the remove the sensor cover, turning counterclockwise.
3. Pull the old sensor out.
4. Gently push a new sensor into the compartment.

**Important!** Ensure that the Honeywell Analytics part number matches the sensor that was removed.

**WARNING!** Use only the same sensor model as the one installed when the monitor was purchased.

5. Replace the sensor compartment cover using by turning it clockwise, using the hexagonal end of the tool.
6. Replace the filter holder by turning it clockwise, using the 3-pin end of the tool.

**Note:** Always recalibrate the MeshGuard LEL after service to ensure functionality.

## 7 Troubleshooting

Failure Symptom	Cause	Solution
Cannot turn on	<p>Battery charge too low</p> <p>Battery has been changed</p> <p>New battery needs to be discharged before use</p>	<p>Replace battery</p> <p>Wait at least 60 seconds to turn on MeshGuard LEL</p> <p>Contact your Honeywell Analytics Representative for information on batteries</p>
Abnormally high reading	<p>Incorrect gas calibration</p> <p>Sensor low sensitivity to calibration gas</p>	<p>Recalibrate</p> <p>Replace the sensor</p>
“-0” Alarm	<p>Sensor zero drift</p>	<p>Perform zero calibration</p>
Controller cannot receive the MeshGuard LEL’s signal	<p>Too much distance between the MeshGuard LEL and the controller.</p> <p>There is an obstruction between the MeshGuard LEL and the controller.</p> <p>Controller does not receive completed data packet</p> <p>Battery is low</p> <p>MeshGuard LEL and controller have different Pan ID</p>	<p>The distance should be 300 m, line of sight.</p> <p>Deploy RTR MeshGuard LEL or MeshGuard Router(s).</p> <p>Relocate the MeshGuard LEL or deploy RTR MeshGuard LEL or MeshGuard Router(s).</p> <p>Press [Y/+] on the detector to force it to send data packets</p> <p>Replace battery</p> <p>Set both units to have</p>

	numbers	the same Pan ID number
No Antenna Icon	<p>There is no reader or controller nearby. The controller or reader's network has changed.</p> <p>The MeshGuard LEL is out of its RF range.</p> <p>Battery is low</p>	<p>Move the MeshGuard LEL closer to a working controller or reader. Perform the network searching function in diagnostic mode.</p> <p>Move the MeshGuard LEL close to a working controller or reader and Press [Y/+]</p> <p>Replace battery</p>
Others		<p>Turn MeshGuard LEL off and on again.</p> <p>Consult Honeywell Analytics Technical Support</p>

## 8 Alarm Signal Summary

Alarm Mode	When	LCD	Buzzer & LED
Over Range	LEL > 100% LEL		3 beeps per second
High Alarm	> high alarm setting		3 beeps per second
Low Alarm	> low alarm setting		2 beeps per second
Zero Drift	< 0% LEL		1 beep per second
Battery Low	< 3.2V		1 beep per minute
Battery Exhausted	< 3.1V		1 beep per second

## 9 Appendix A

### Warnings

#### Read Before Operating

This manual must be carefully read by all individuals who have or will have the responsibility of using, maintaining, or servicing this product. The product will perform as designed only if it is used, maintained, and serviced in accordance with the manufacturer's instructions.

#### Warning:

Use only the Lithium battery provided by Honeywell Analytics. This instrument has not been tested in an explosive gas/air atmosphere having an oxygen concentration greater than 21%. Substitution of components may impair suitability for intrinsic safety. Replacement of batteries only in non-hazardous locations.

**STATIC HAZARD:** Clean only with a damp cloth.

For safety reasons this equipment must be operated and serviced by qualified personnel only. Read and understand instruction manual completely before operating or servicing. Any rapid up-scale reading followed by a declining or erratic reading may indicate a gas concentration beyond upper scale limit, which may be hazardous.

#### FCC Part 15 statement and CE

This device complies with Part15 of the FCC rules. Operation is subject to the following two conditions: (1) This device may not cause harmful interference, and (2) this device must accept any interference received, including interference that may cause undesired operation.

# 10 Appendix B: Controlled Part Of MeshGuard LEL (FTD 3000) Manual

**Intrinsic Safety:** IECEx TSA 09.0001X Ex ia I/IIC T4

CE 0575  IM1/II 1G Ex ia I/II C T4

DNV 09 ATEX 55990 X

cCSAus Class I, Division 1, Groups A,B,C, D T4

$-40^{\circ}\text{C} \leq T_{\text{amb}} \leq 50^{\circ}\text{C}$

**Entity Parameters:**  $U_i = 3.6\text{V}$ ,  $C_i = 67\mu\text{F}$ ,  $L_i/R_i = 3.5\mu\text{H}/\text{ohm}$

**EM Immunity:** No effect when exposed to  $0.43\text{mW}/\text{cm}^2$  RF interference (5-watt transmitter at 12").

**Temperature:**  $-40^{\circ}\text{C}$  to  $50^{\circ}\text{C}$  ( $-40^{\circ}\text{F}$  to  $122^{\circ}\text{F}$ )

**Humidity:** 0% to 95% relative humidity (non-condensing)

## **WARNING! (cCSAus only)**

CERTIFICATION ONLY APPLIES FOR FIXED  
INSTALLATIONS.

## **WARNING!**

ONLY THE COMBUSTIBLE GAS DETECTION PORTION OF  
THIS INSTRUMENT HAS BEEN ASSESSED FOR  
PERFORMANCE.

UNIQUIMENT, LA PORTION POUR DETECTOR LES GAZ  
COMBUSTIBLES DE CET  
INSTRUMENT A ÉTÉ ÉVALUÉE.

## **CAUTION!**

HIGH OFF-SCALE READINGS MAY INDICATE AN  
EXPLOSIVE CONCENTRATION OF GAS.

**Note:** Users are recommended to refer to ISA -RP12.13, Part II-1987 for general information on installation, operation, and maintenance of combustible gas detection instruments.

- Only the combustible gas detection portion of this instrument has been assessed for performance.
- Any rapid up-scale reading followed by a declining or erratic reading may indicate a gas concentration beyond upper scale limit which may be hazardous.

**WARNING (cCSAus only):** WIRELESS COMMUNICATION IS INTENDED FOR USE AS A SECONDARY REMOTE ALARM STATUS NOTIFICATION ONLY. PRIMARY ALARMING OF COMBUSTIBLE GAS HAZARDS IS PROVIDED LOCALLY BY THE DETECTOR.

**WARNING:** SUBSTITUTION OF COMPONENTS MAY IMPAIR INTRINSIC SAFETY.

**Range, Resolution & Response Time:**

**Range:** 0 to 100% LEL

**Resolution:** 1% LEL

**Response Time (T<sub>90</sub>):** 15 seconds

**Caution:**

Refer to Honeywell Analytics Technical Note TN-114 for sensor cross-sensitivities.

Refer to Honeywell Analytics Technical Note TN-144 for LEL sensor poisoning.

# Sensor And Internal Battery Replacement

The MeshGuard LEL is permanently mounted to a solid surface by first securing it in its steel enclosure (a screw through the back mates with the MeshGuard LEL) and then securing the enclosure to a solid surface such as a wall or the metal mounting plate.

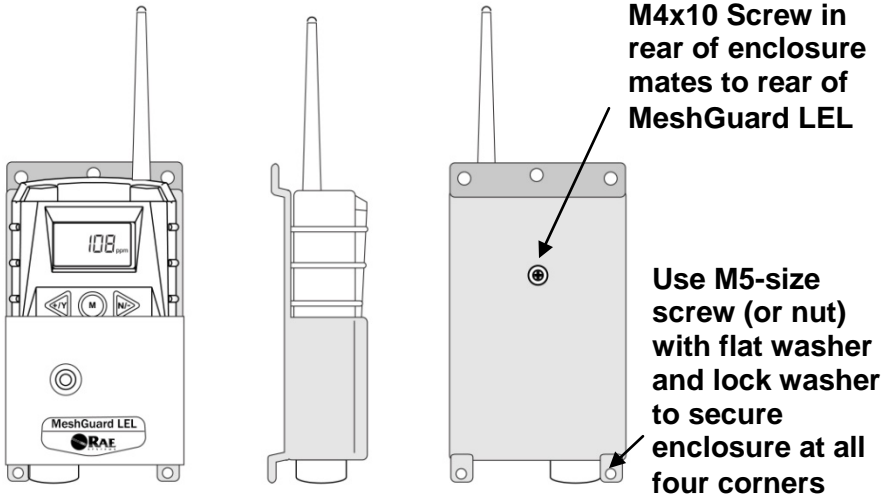

**Front, side, and rear views of the steel enclosure show how the MeshGuard LEL is secured for mounting.**

With the MeshGuard LEL securely in its housing, you can remove the cover over the battery compartment so that you can replace the internal battery in the MeshGuard LEL. Use the sensor and battery removal tool as shown.

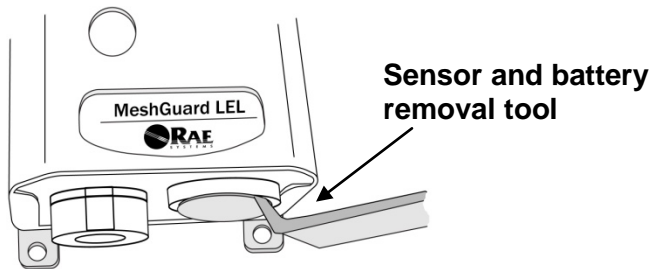

**WARNING:** Use only battery provided by Honeywell Analytics for the internal battery. The internal battery must be replaced under a Hot Work Permit, where the atmosphere is determined to be non-hazardous while the battery is being replaced.

## MeshGuard LEL Installation With External Power Battery Pack (FTB-1000)

Use M8-size screw (or nut), flat washer, and lock washer

Use M8-size screw (or nut), flat washer, and lock washer

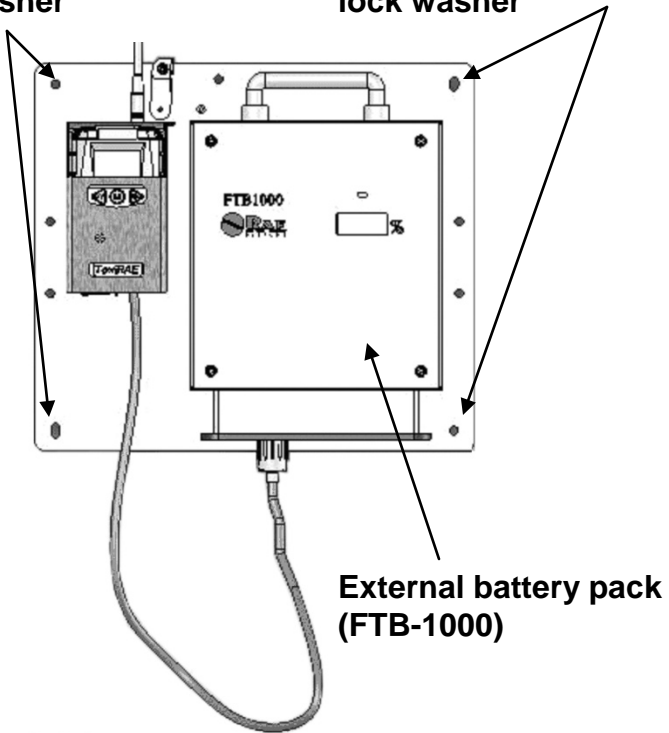

**Note:** The plate holding the battery pack and FTD-3000 LEL must be mounted on a solid, flat surface.

## Turning The Meshguard LEL On

To turn the MeshGuard LEL on, hold down [MODE] for 2 seconds.

**Caution:** The alarm is very loud. During startup, you can mute most of the sound by holding a finger over the alarm port.

**Note:** Do not put tape over the alarm port to permanently mute it.

When starting up, the MeshGuard LEL simultaneously turns the backlight on and off, beeps once and blinks once. The screen shows:

**On...**  
**Firmware version**  
**Count down from 15 to 0**

The MeshGuard LEL performs a final checkout and the screen shows a countdown to full operational functionality.

## Turning The MeshGuard LEL Off

Press and hold [MODE]. In 2 seconds, a 5-second countdown to shutoff begins. You must hold your finger on the key for the entire shutoff process. If you remove your finger from the key during the countdown, the shutoff operation is canceled and the MeshGuard continues normal operation.

The countdown proceeds as follows, accompanied at each step with an alarm beep and light flash. The display shows the countdown in sequence:

**5**  
**4**  
**3**  
**2**  
**1**  
**off**

When you see “off,” release your finger from the [MODE] key. The MeshGuard LEL is now off.

**Caution:** The alarm is very loud. During shutdown, you can mute most of the sound by holding a finger over the alarm port.

## Resetting After An Alarm

When a gas concentration exceeds 100% of LEL, the MeshGuard LEL displays “OVR” and its buzzer and LED are activated. In order to reset the MeshGuard LEL and turn off the alarms from that event, press the [Y/+ ] key. This clears the alarm.

**Note:** Clearing the alarm does not shut off the sensor. Therefore, the next time the gas concentration exceeds 100% of LEL, the MeshGuard LEL will again alert you.

# Programming Mode

Programming Mode can be entered from Normal Mode or Diagnostic Mode. This mode contains most adjustable settings for the MeshGuard. It is organized into four submenus:

The following diagram shows how to enter Programming Mode from Normal Mode:

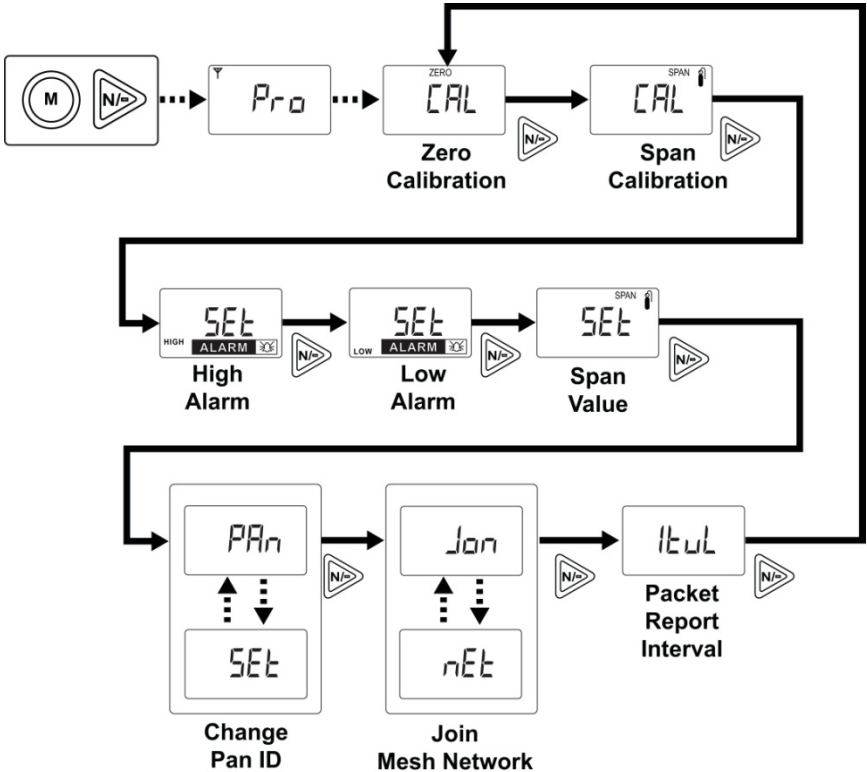

**Modify Span Gas Value.** This function allows selection of the gas concentration to the settings, press [MODE] to repeat stepping through the choices.

**Back.** Press [MODE] to return to the top of the Calibrate Monitor menu, or press [Y/+] to return to the top of the Normal Mode menu.

## Change Alarm Limits

The high and low alarm limits, alarms are triggered, can be modified in this set of menus, (the STEL and TWA can be set in toxic gas versions).

**Alarm Signals.** During each measurement period, the gas concentration is compared with the programmed alarm limits (gas concentration alarm limit settings: Low, High, TWA and STEL). If the concentration exceeds any of the preset limits, the loud buzzer, red flashing LED, and vibration alarm are activated immediately to warn of the alarm condition. In addition, the MeshGuard LEL alarms if the battery voltage falls below a preset voltage level.

When the low battery alarm occurs, there will be approximately 20 to 30 minutes of operating time remaining. When the battery voltage falls below the low threshold, the MeshGuard LEL turns off automatically.

# Calibrating MeshGuard LEL

- Calibration intervals and procedures may vary due to national legislation.
- Calibration gas flow should be verified and be between 400 cc/mn and 800 cc/min.

## Connecting Calibration Gas

1. Connect the calibration gas to the MeshGuard LEL as shown.

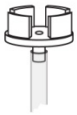

**Calibration adapter  
connected to calibration  
gas cylinder**

## 10.1 Zero Calibration

When “CAL” and “go” are displayed in alternation, and “ZERO” is shown, the MeshGuard LEL is ready to perform a zero calibration.

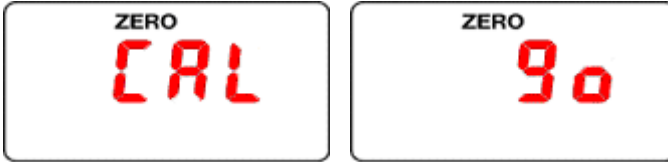

Press [Y/+]. The LCD displays “go.”



The display counts down from 10 to 0.

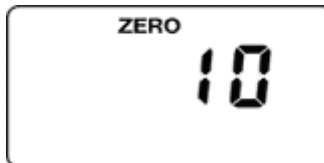

After the countdown reaches 0, the LCD displays “dn,” for “done.” The reading should show 0 (zero). Otherwise, repeat the zero calibration.

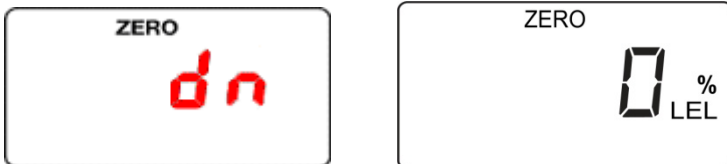

**Note:** To stop zero calibration before the countdown reaches 0, press any key. The LCD displays “no” and advances to the next programming menu, Span calibration.

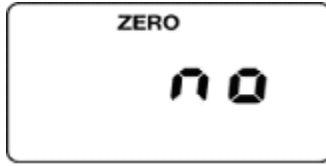

## 10.2 Span Calibration

“CAL” and “go” flash in alternation, and “SPAn” is shown. The MeshGuard LEL is now ready to perform a span calibration.

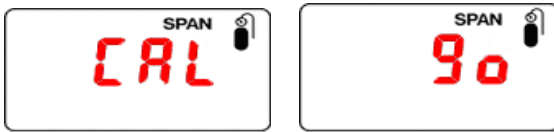

To start calibration, press [Y/+]. The LCD displays “go.”

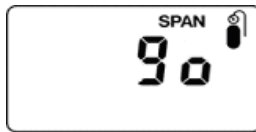

The MeshGuard LEL waits for 10 seconds so that you have time to connect the span gas. Connect the calibration gas adapter to the MeshGuard LEL, and connect the gas cylinder to the adapter. Start the flow of gas.

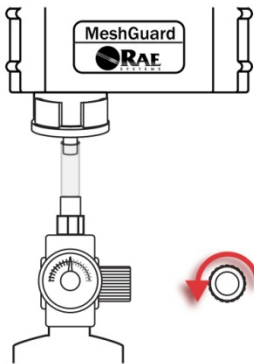

When the gas flow starts, the LCD displays “gAS” and the span concentration value.

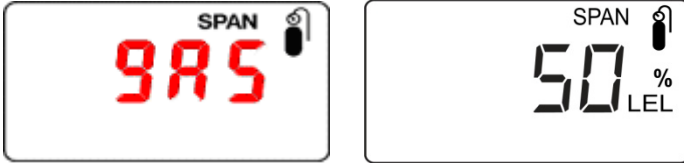

The MeshGuard LEL now counts down to 0.

**Note:** The countdown time varies according to the type of sensor used in the MeshGuard LEL.

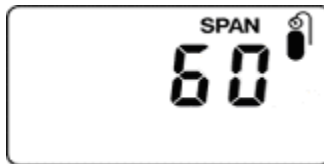

After counting down and reaching 0, the LCD displays “dn.” The reading should be the span concentration value. Otherwise, the span calibration should be repeated.

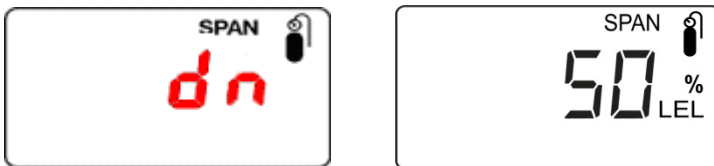

If the MeshGuard LEL does not detect gas after counting down to 0, the LCD displays “Err” (for “error”). The LED glows red and the buzzer sounds to provide extra warning. The MeshGuard LEL automatically returns to the span calibration display.

**Note:** This could mean the sensor is contaminated or expired.



**Note:** To stop span calibration before the countdown reaches 0, press any key. The LCD displays “no” and advances to the next programming menu, Change High Alarm.

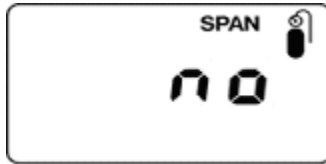

If the sensor fails, try to calibrate it again. If calibration fails again, replace the sensor.

# 11 External Battery Replacement

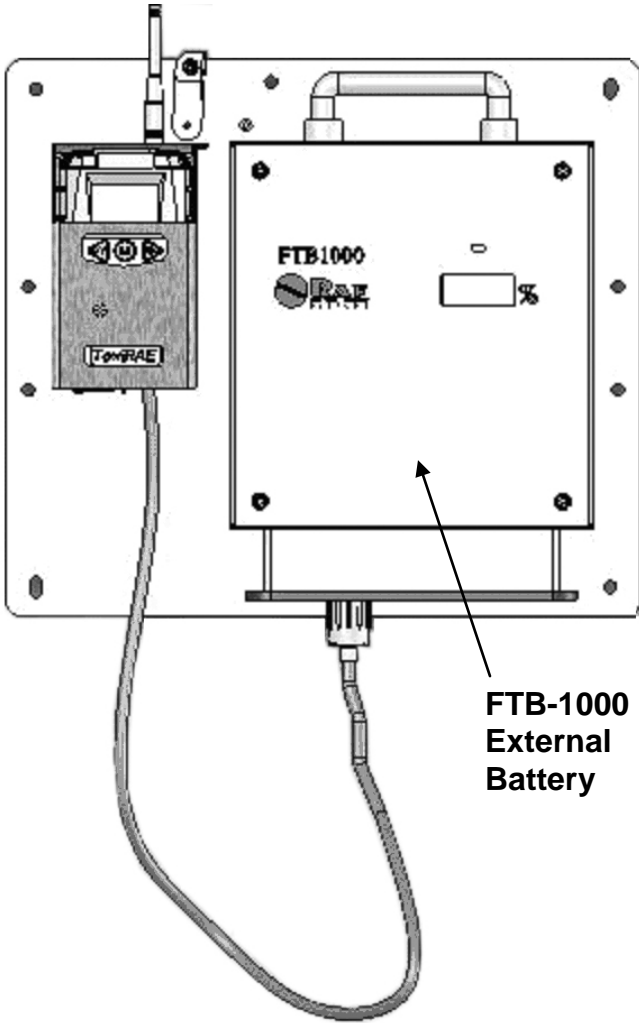

## **11.1 External battery replacement**

1. Unplug the battery connector
2. Loosen the safety screw holding the battery
3. Mount a new battery on the mounting bracket
4. Tighten the safety screw
5. Connect the Meshguard LEL to the battery.
6. Switch on the MeshGuard LEL.

**Note:** Always recalibrate the MeshGuard LEL after service.

## 11.2 Sensor And Internal Battery Replacement (ATEX/IECEX Only)



## 11.3 Battery Replacement

Honeywell Analytics offers two types of batteries: internal battery and external battery pack.

1. Use the 3-pin end of the tool to unscrew and open the battery cover by turning it counterclockwise.
2. Remove the battery.
3. Insert the new battery with its positive (“+”) pole towards inside of the unit.

4. Replace the battery cover by turning it clockwise with the 3-pin end of the tool.

**Note:** Only change the battery in non-hazardous locations, and use the battery only provided by Honeywell Analytics. Only remove the external battery adapter in non-hazardous locations.

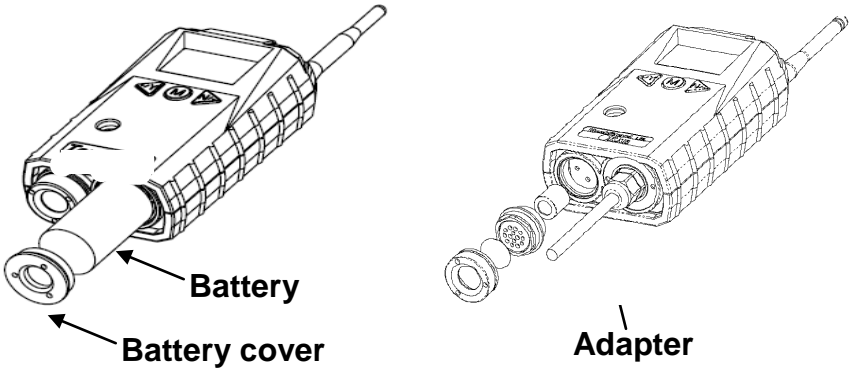

## 11.4 Sensor Replacement

1. Use the 3-pin end of the tool to unscrew and open the filter holder at the bottom of the monitor.

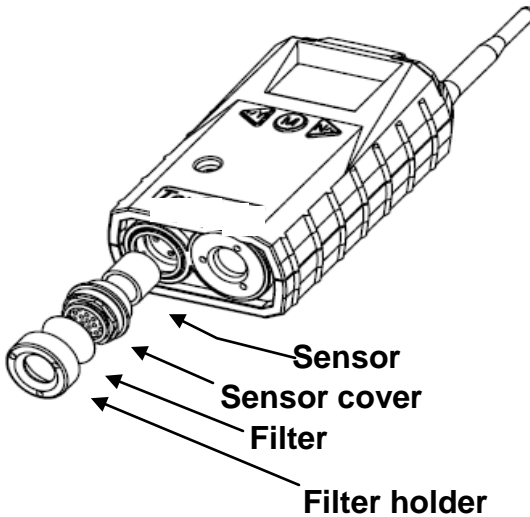

2. Use the hexagonal end of the tool to open the remove the sensor cover, turning counterclockwise.
3. Pull the old sensor out.
4. Gently push a new sensor into the compartment.
5. Replace the sensor compartment cover using by turning it clockwise, using the hexagonal end of the tool.
6. Replace the filter holder by turning it clockwise, using the 3-pin end of the tool.







**WARNING:** Only replace the sensor in non-hazardous locations.

## 12 Troubleshooting

Failure Symptom	Cause	Solution
Cannot turn on	<p>Battery charge too low</p> <p>Battery has been changed</p> <p>New battery needs to be discharged before use</p>	<p>Replace battery</p> <p>Wait at least 60 seconds to turn on MeshGuard LEL</p> <p>Contact your Honeywell Analytics Representative for information on batteries</p>
Abnormally high reading	<p>Incorrect gas calibration</p> <p>Sensor low sensitivity to calibration gas</p>	<p>Recalibrate</p> <p>Replace the sensor</p>
“—0” Alarm	Sensor zero drift	Perform zero calibration
Controller cannot receive the MeshGuard LEL’s signal	<p>Too much distance between the MeshGuard LEL and the controller.</p> <p>There is an obstruction between the MeshGuard LEL and the controller.</p> <p>Controller does not receive completed data packet</p> <p>Battery is low</p>	<p>The distance should be 300 m, line of sight. Deploy RTR MeshGuard LEL or MeshGuard Router(s).</p> <p>Relocate the MeshGuard LEL or deploy RTR MeshGuard LEL or MeshGuard Router(s).</p> <p>Press [Y/+] on the detector to force it to send data packets</p> <p>Replace battery</p>

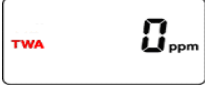
	MeshGuard LEL and controller have different Pan ID numbers	Set both units to have the same Pan ID number
No Antenna Icon	<p>There is no reader or controller nearby. The controller or reader's network has changed.</p> <p>The MeshGuard LEL is out of its RF range.</p> <p>Battery is low</p>	<p>Move the MeshGuard LEL closer to a working controller or reader. Perform the network searching function in diagnostic mode.</p> <p>Move the MeshGuard LEL close to a working controller or reader and Press [Y/+].</p> <p>Replace battery.</p>
Others		<p>Turn MeshGuard LEL off and on again.</p> <p>Consult Honeywell Analytics Technical Service</p>

# 13 Alarm Signal Summary

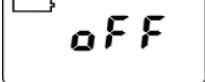
Alarm Mode	When	LCD	Buzzer & LED
Over Range	H <sub>2</sub> S > 100 ppm CO > 500 ppm or 2000 ppm or 100% LEL		3 beeps per second
High Alarm	> high alarm setting		3 beeps per second
Low Alarm	> low alarm setting		2 beeps per second
TWA	> TWA setting		1 beep per second
STEL	> STEL Setting		1 beep per second
Zero Drift	< 0 ppm		1 beep per second
Battery Low	< 3.2V		1 beep per minute
Battery Exhausted	< 3.1V		1 beep per second

**Ordering Replacement Parts:** If you need replacement parts, please contact Honeywell Analytics Representative.

**Find out more**

[www.honeywellanalytics.com](http://www.honeywellanalytics.com)

**Contact Honeywell Analytics:****Europe, Middle East, Africa**

Life Safety Distribution AG  
Javastrasse 2  
8604 Hegnau  
Switzerland  
Tel: +41 (0)44 943 4300  
Fax: +41 (0)44 943 4398  
[gasdetection@honeywell.com](mailto:gasdetection@honeywell.com)

**Customer Service:**

Tel: +800 333 222 44 (Freephone number)  
Tel: +41 44 943 4380 (Alternative number)  
Fax: +800 333 222 55  
Middle East Tel: +971 4 450 5800 (Fixed Gas Detection)  
Middle East Tel: +971 4 450 5852 (Portable Gas Detection)  
India Tel: +91 124 4752700

**Americas**

Honeywell Analytics Inc.  
405 Barclay Blvd.  
Lincolnshire, IL 60069  
USA  
Tel: +1 847 955 8200  
Toll free: +1 800 538 0363  
Fax: +1 847 955 8210  
[detectgas@honeywell.com](mailto:detectgas@honeywell.com)

**Asia Pacific**

Honeywell Analytics Asia Pacific  
#701 Kolon Science Valley (1)  
43 Digital-Ro 34-Gil, Guro-Gu  
Seoul 152-729  
Korea  
Tel: +82 (0)2 6909 0300  
Fax: +82 (0)2 2025 0328  
India Tel: +91 124 4752700  
[analytics.ap@honeywell.com](mailto:analytics.ap@honeywell.com)

**Technical Services**

EMEA1: [HAexpert@honeywell.com](mailto:HAexpert@honeywell.com)  
US: [ha.us.service@honeywell.com](mailto:ha.us.service@honeywell.com)  
AP: [ha.ap.service@honeywell.com](mailto:ha.ap.service@honeywell.com)

[www.honeywell.com](http://www.honeywell.com)

**Please Note:**

While every effort has been made to ensure accuracy in this publication, no responsibility can be accepted for errors or omissions. Data may change, as well as legislation and you are strongly advised to obtain copies of the most recently issued regulations, standards and guidelines. This publication is not intended to form the basis of a contract.

# Honeywell

13422\_REV F\_10/2011  
H\_MAN0971\_EMEA1

P/N D01-4002-000

© 2014 Honeywell Analytics



**D**ETECTION | **S**AFETY | **P**ROTECTION

For Pricing or Further  
Information Please Contact Us.



**+441158390495**



**[www.manonglobal.com](http://www.manonglobal.com)**



**[sales@manonglobal.com](mailto:sales@manonglobal.com)**

---

**Leading UK Suppliers In  
Gas Detection, Safety & Protection  
Products  
Brand New & Genuine OEM Parts  
UK & Worldwide Deliveries Available**



Worldwide Delivery



1000+ Genuine Parts & Equipment